

Project 18-40

SNIC Bifurcation and its Applications to MEMS

By: Shay Kricheli

Supervisor: Dr. Oriel Shoshani

21.6.18

Introduction

Generation of a Frequency Comb

A set of discrete equally spaced frequencies

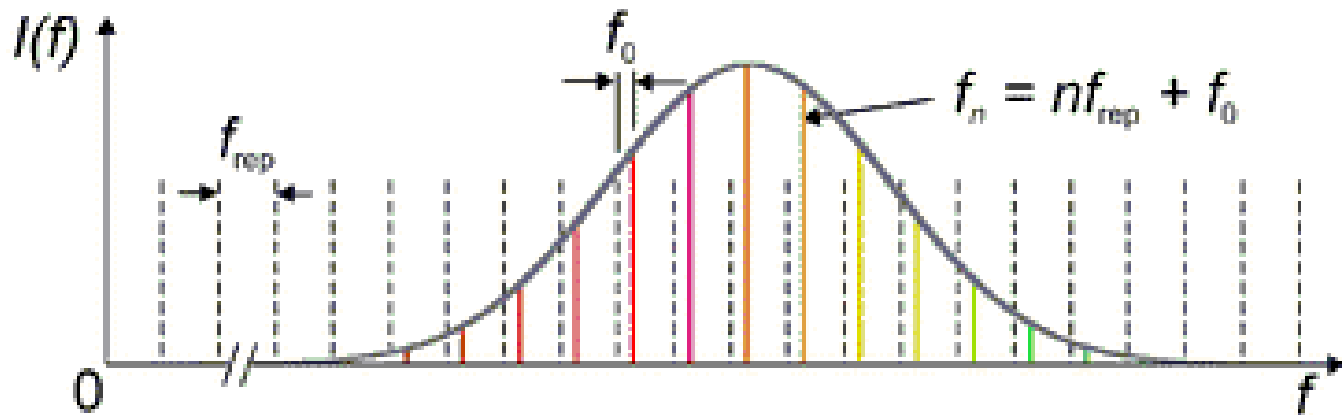

$$f_n \equiv f_0 + n f_r$$

Applications

What can we do with it?

- Transition from one frequency range to another
- Optical and Atomic clocks
- Precision Spectroscopy
- Precision microwave generation

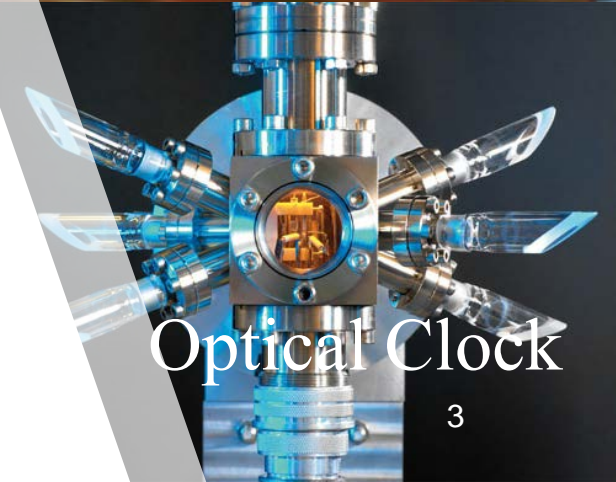
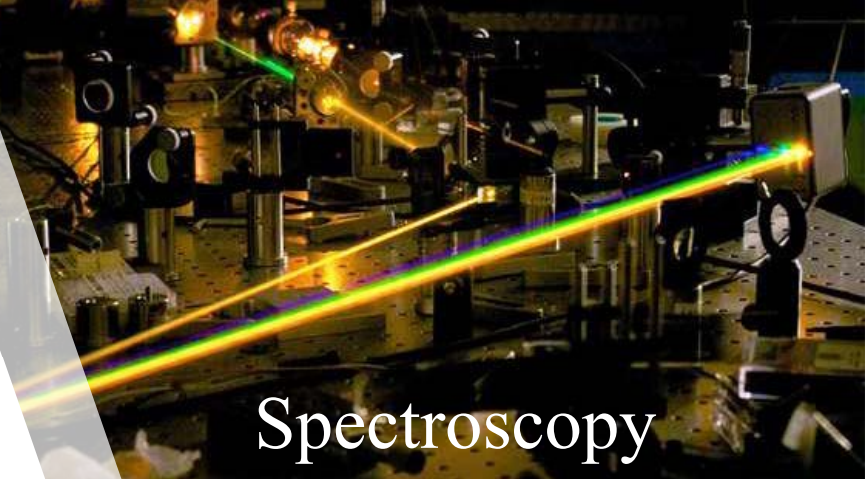

Motivation

Why mechanically?

- Electrical systems produce noise – corresponding to a poor comb
- Optical systems are expensive to implement
- A mechanical model is more precise



Project Goals

- Producing a frequency comb by mechanical means
- Using a simple dynamic model
- Verifying the model's validity
- Providing insight on usage with MEMS

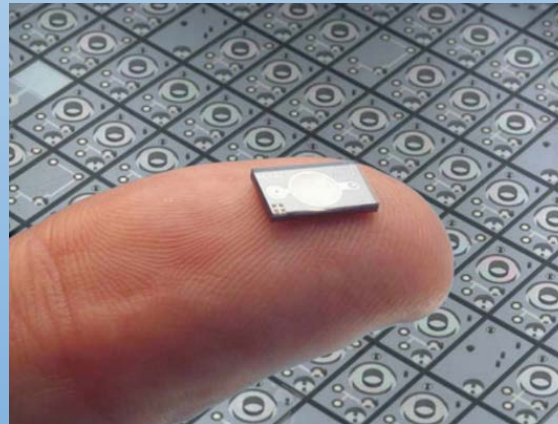
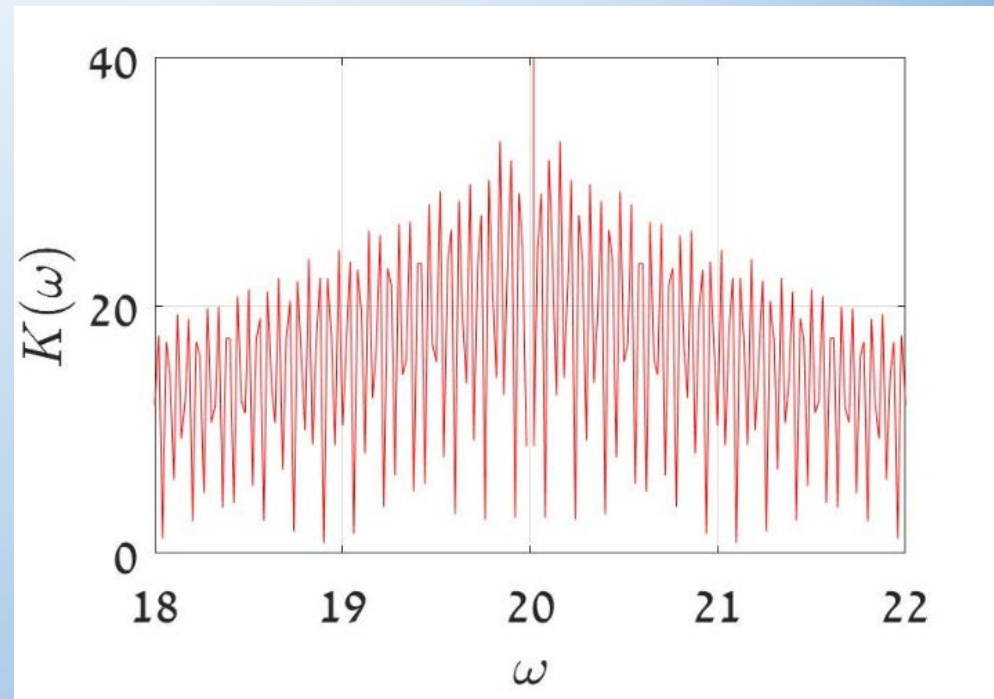

- Vibration analysis of a MEMS beam exhibiting non-linear dynamics for a formation of a limit cycle
- Use of closed loop control to maintain the beam at steady amplitude
- External perturbation of the beam
- Causing a SNIC bifurcation
- Forming the desired frequency comb

Methods of Execution

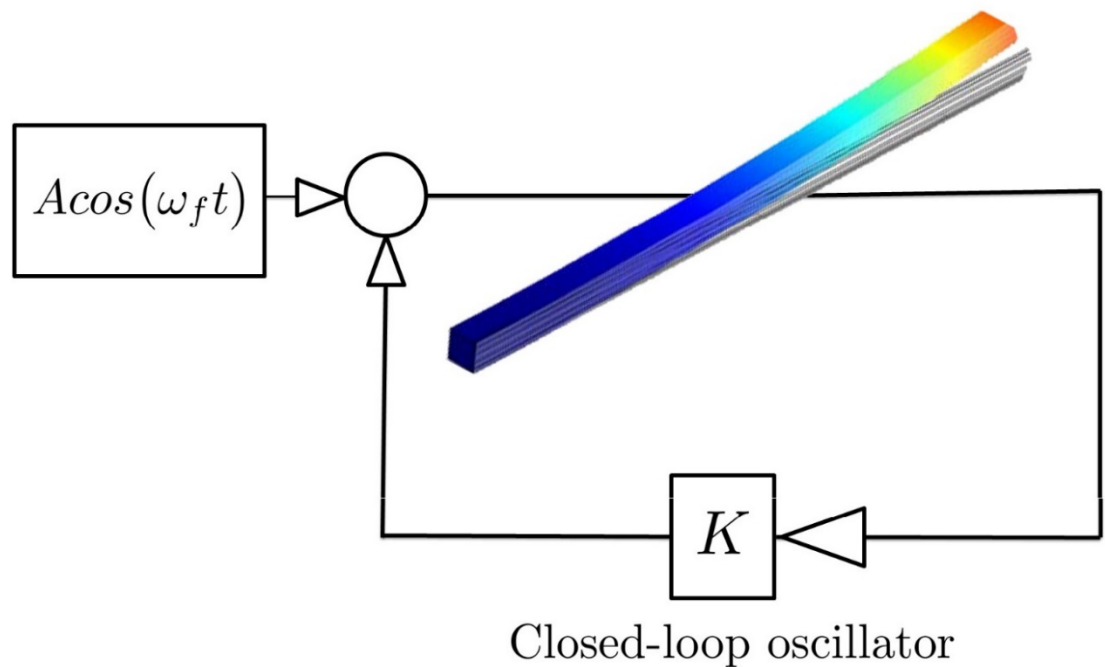

What is a Bifurcation?

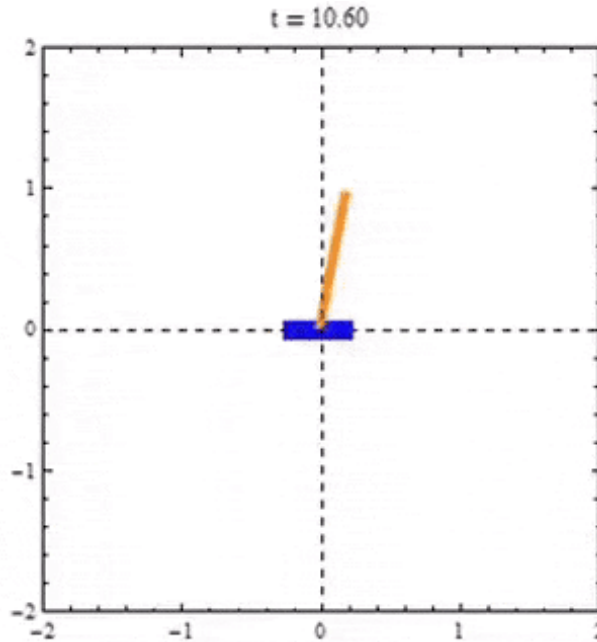

An abrupt qualitative change in a behavior of a dynamical system due to a change in one of its governing parameters

Inverted pendulum exhibiting a bifurcation

Bifurcation Example

The Logistic Map

$$x_{n+1} = rx_n(1 - x_n)$$

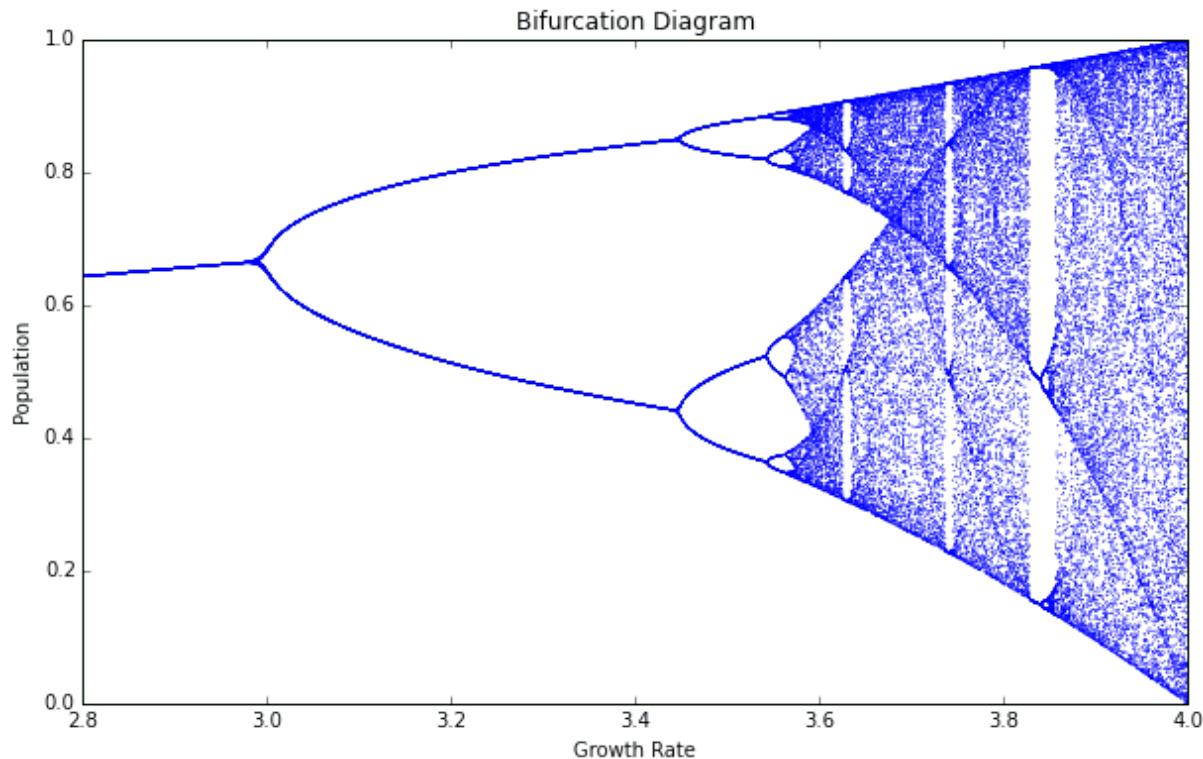

Models
population
growth and
decay using an
iterative
equation
governed by r –
the growth rate

SNIC Bifurcation

Saddle-Node on Invariant Circle is a bifurcation where two equilibrium points collide and cause the system to settle on an infinite limit cycle

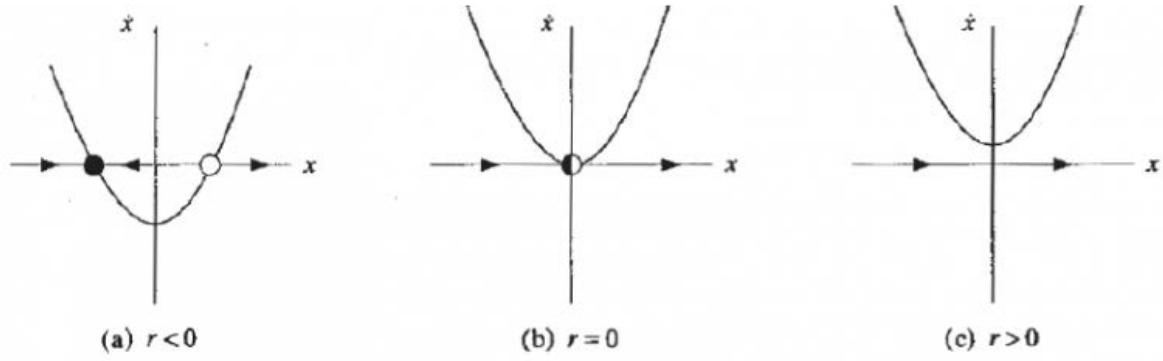
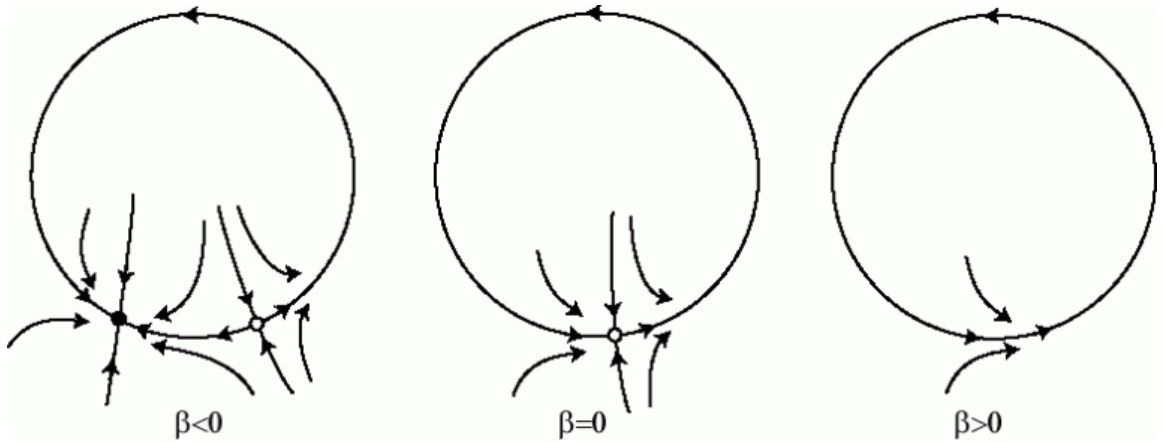

How will SNIC help us get the comb?

- Driver frequency slightly detuned from the beam's eigenfrequency
- Due to effects of injection pulling, a SNIC bifurcation will occur for certain physical parameters of the beam
- In the bifurcation critical point, where the oscillators are close to locking – the frequency comb will appear

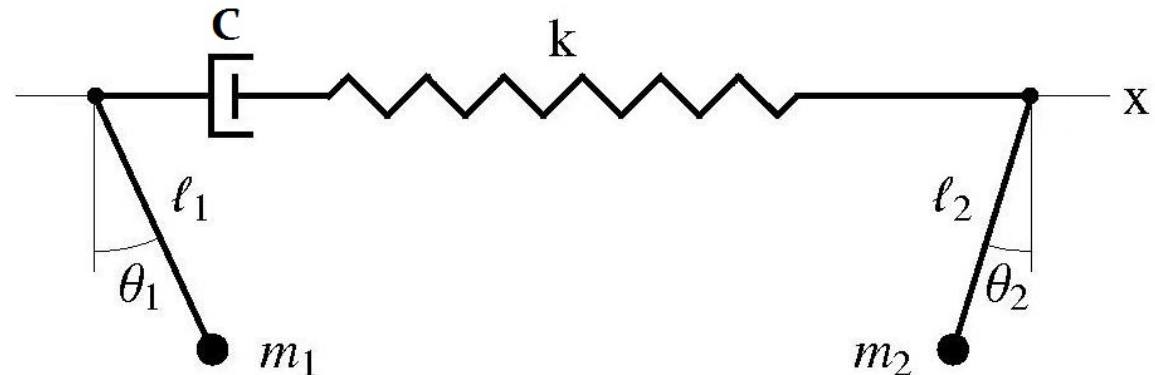

Mathematical Modeling

A model from Ron Lifshitz and M. C. Cross. “Nonlinear Dynamics of Nanomechanical and Micromechanical Resonators”

$$\begin{aligned} \rho A \frac{\partial^2 u(x, t)}{\partial t^2} + 2\zeta \frac{\partial u(x, t)}{\partial t} - \tau[u(x, t)] \frac{\partial^2 u(x, t)}{\partial x^2} + EI \frac{\partial^4 u(x, t)}{\partial x^4} \\ = [A \cos(\omega_d t) + \psi[u(x, t)]] \delta(x - x_0) \end{aligned}$$

The beam is taken to be clamped-clamped so the boundary conditions are

$$u(0, t) = u(l, t) = \frac{\partial u}{\partial x}(0, t) = \frac{\partial u}{\partial x}(l, t) = 0$$

Spatial Function Solution

We assume:

- Variable Separation
- Single Mode Assumption for the first mode

Yielding the shape function of the beam's first mode

$$X_1(s) = 0.618 \cdot \left[\sin(s) - \sinh(s) \right] - 0.629 \cdot \left[\cos(s) - \cosh(s) \right]$$

$$s \in [0, 4.75]$$

Temporal Function Solution

Normalizing with respect to time and length results in the following equation for the time dynamics

$$\frac{d^2T}{d\tau^2} + 2\tilde{\zeta} \frac{dT}{d\tau} + T + T^3 = \Phi \cos\left(\frac{\omega_d}{\omega_n} \tau\right) + \Gamma \frac{\frac{dT}{d\tau}}{\left|\frac{dT}{d\tau}\right|}$$

Second derivative with respect to normalized time Damping term Linear term Duffing non-linear term External driver Closed loop control function

Using a model from Seshia, we take the Signum function to cancel out the damping

$$\psi = \Gamma \frac{\frac{dT}{d\tau}}{\left|\frac{dT}{d\tau}\right|} \longrightarrow$$

$$a_{SS} = \frac{2\Gamma}{\pi\tilde{\zeta}}$$

Validation of the Model

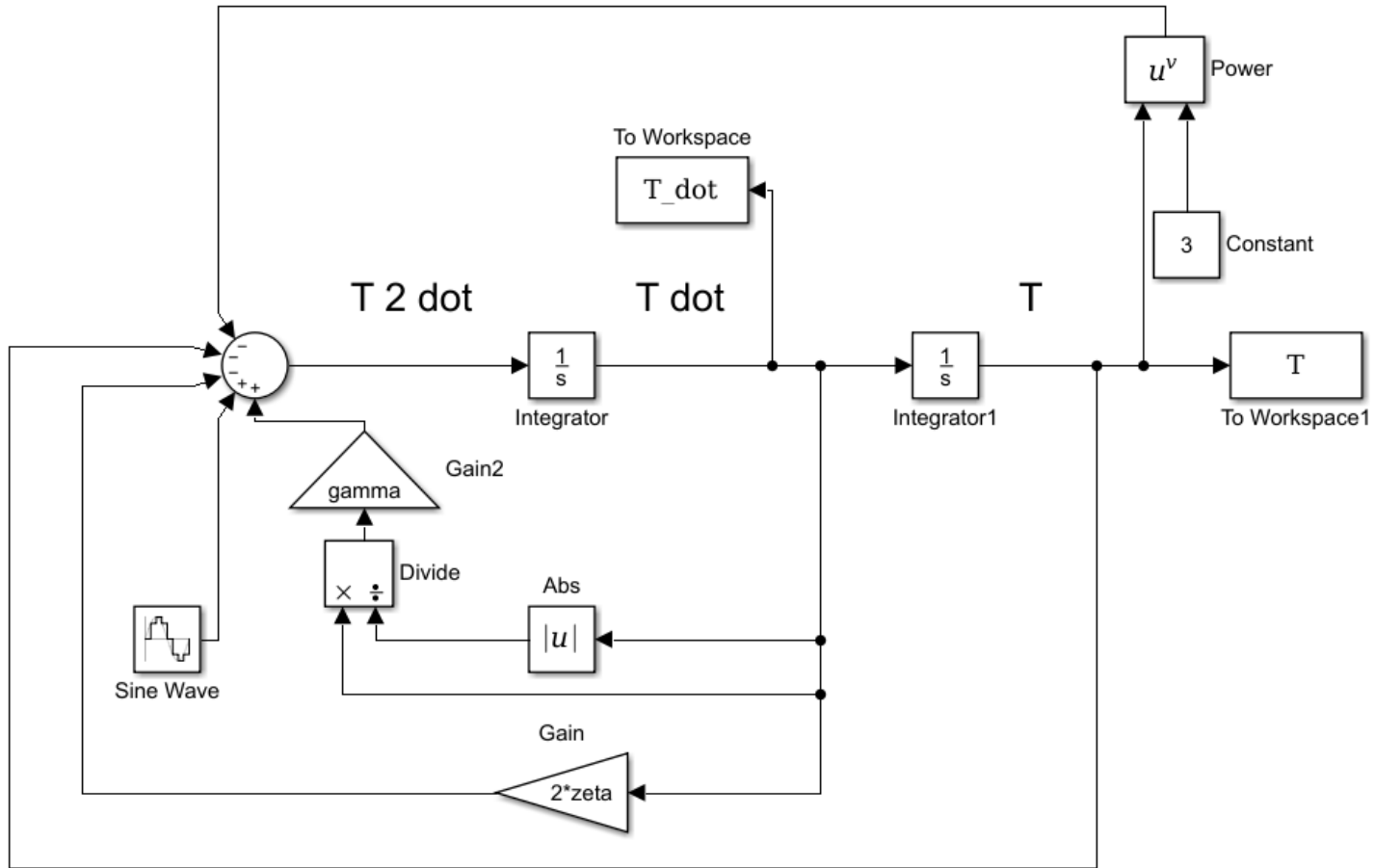

The final equation Simulink model

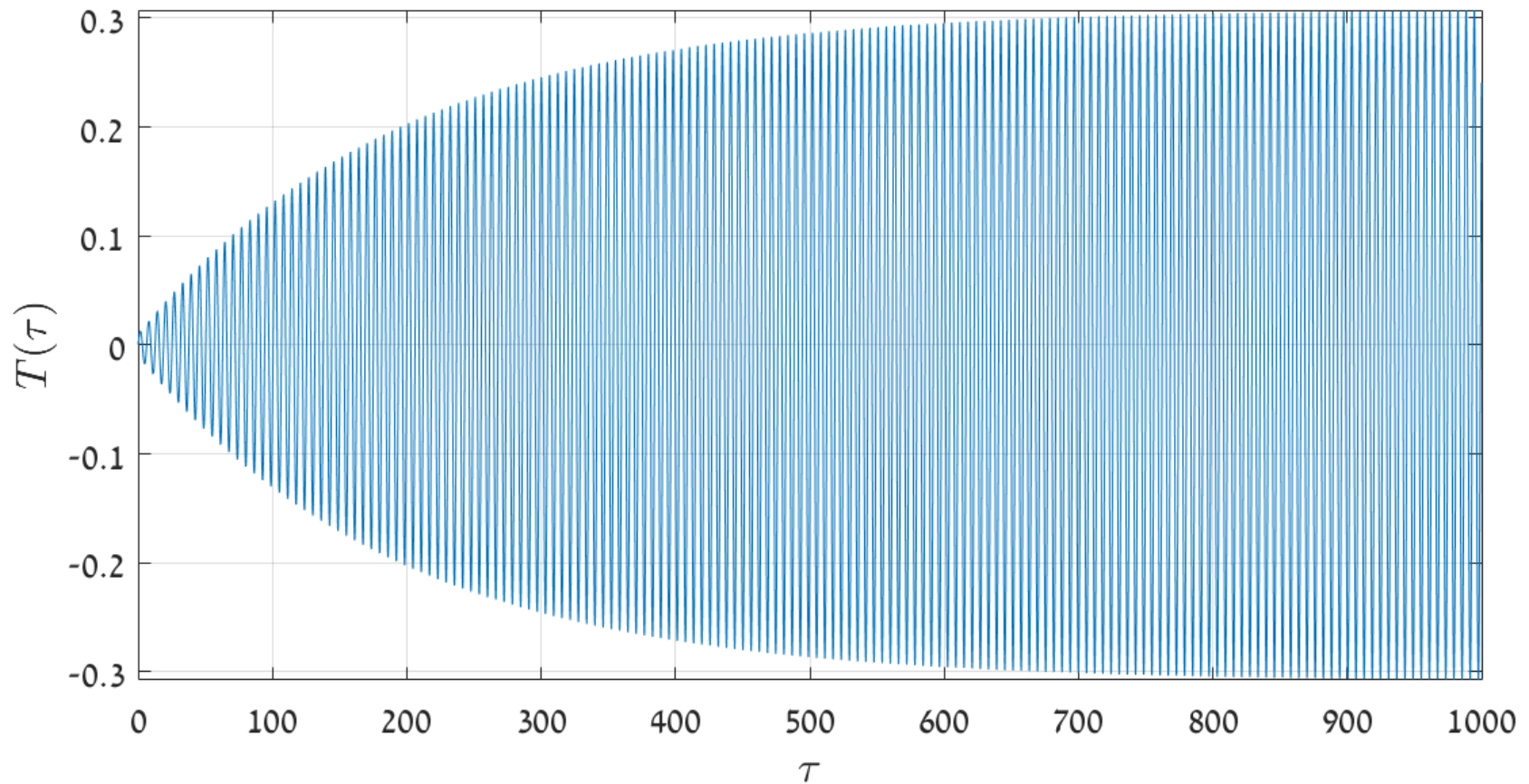

SS Amplitude Simulations 1

Taking $\Gamma = \frac{\tilde{\zeta}}{2}$ we get a period of $\frac{1}{\pi} \approx 0.3$

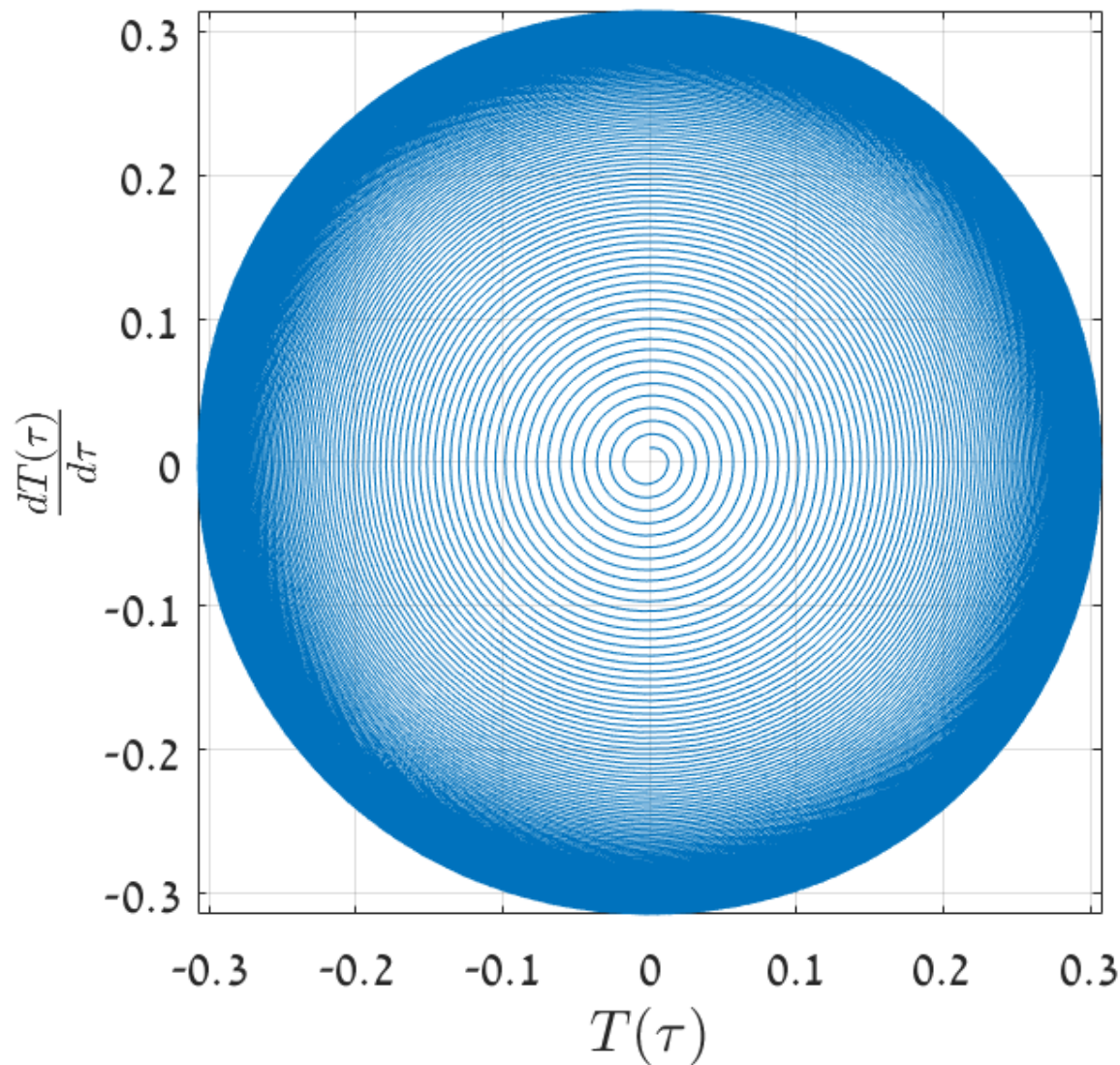

SS Amplitude Simulations 2

Phase space shows a limit cycle of ≈ 0.3

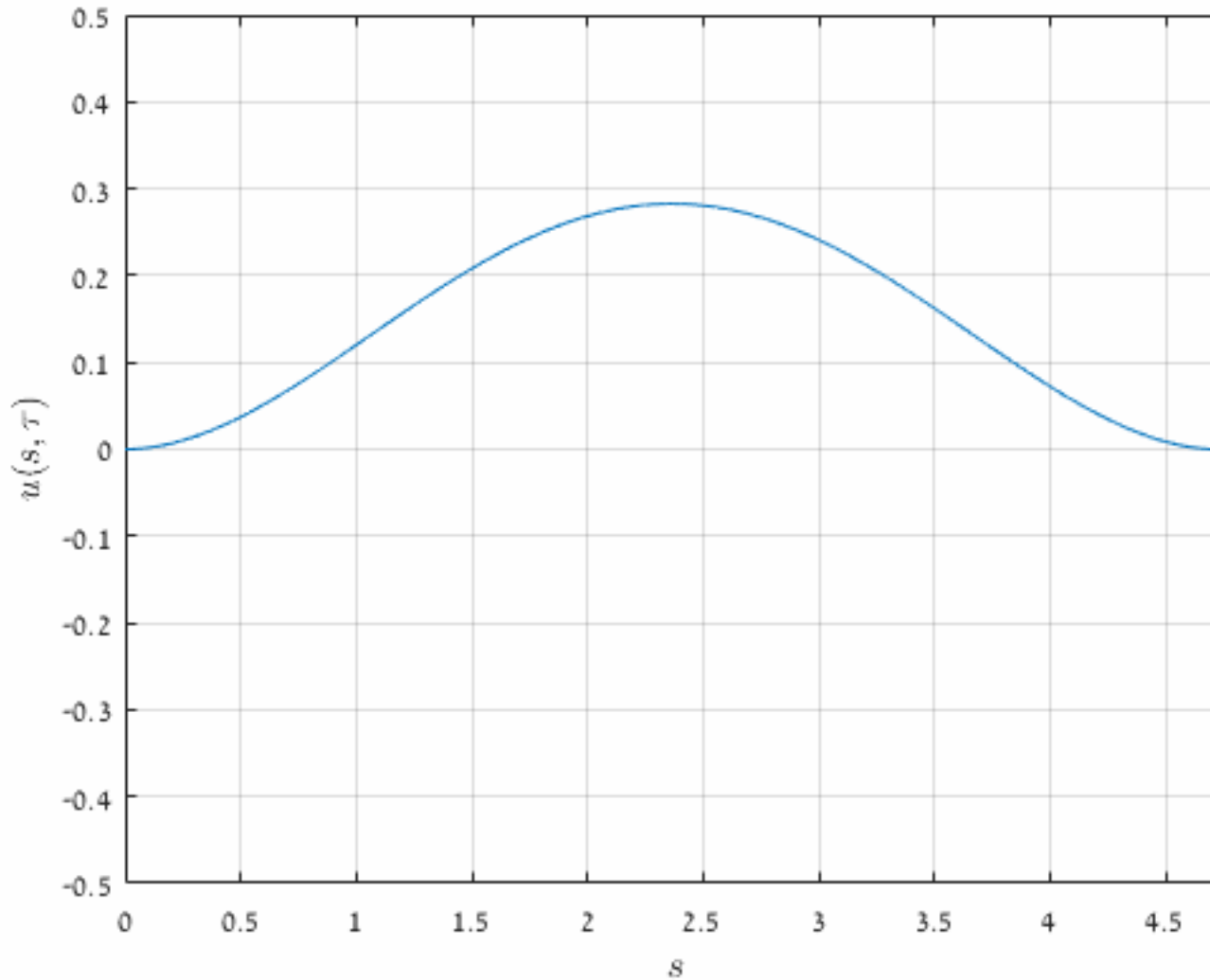

Solution for $u(x, t)$

Using the solution for the spatial and temporal functions

Mid Results

So we get a steady limit cycle,
and with a small driver we can
get the SNIC!

Now we just have to solve the
equation to get the dynamics
of the beam and derive the
phase pull

But.. Even the simple Duffing
equation is not solvable

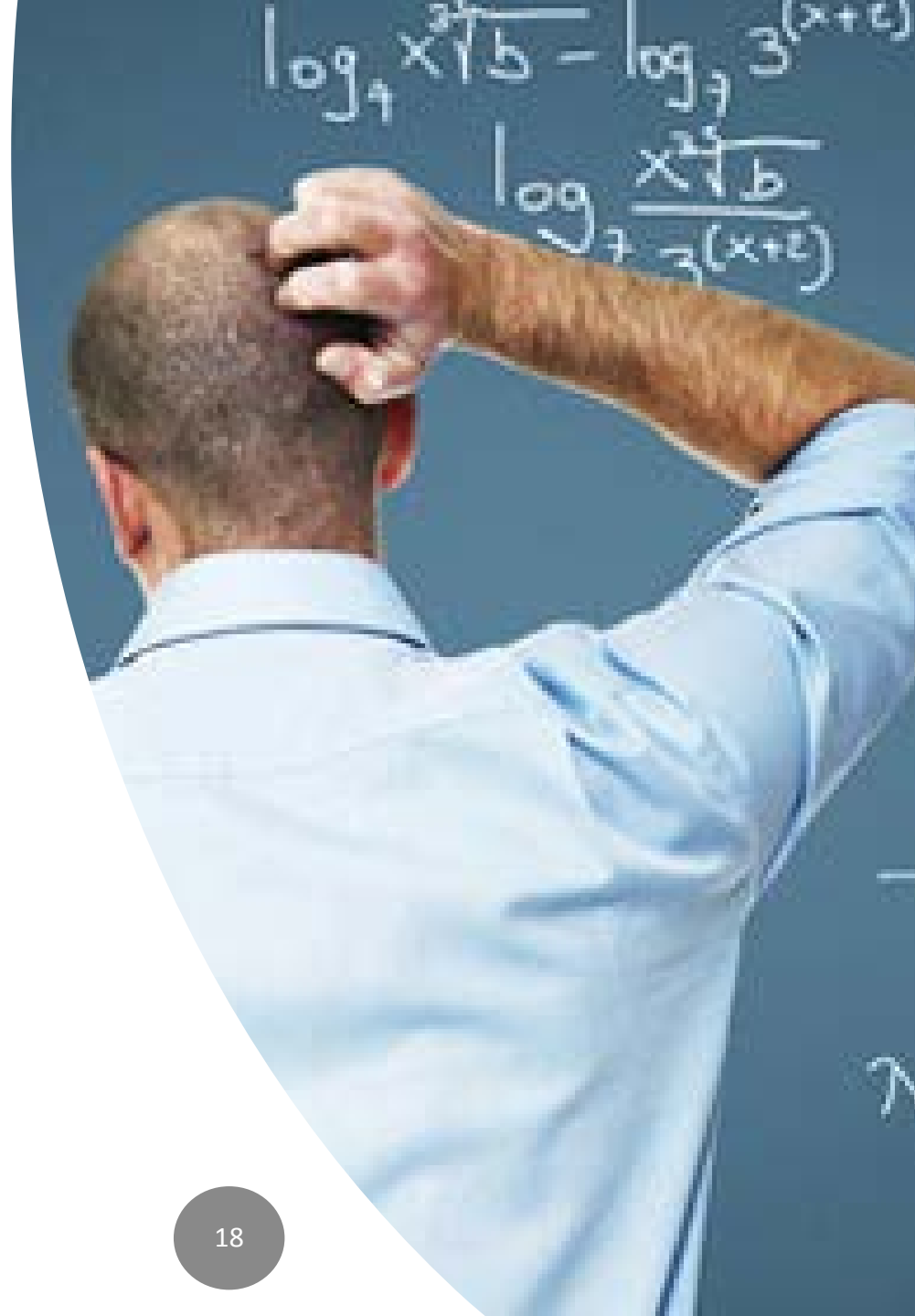

Slow Evolution Model

Using a model of Ashwin A. Seshia for the temporal function

$$T(\tau) = a(\tau) \cos \left[\frac{\omega_d}{\omega_n} \tau + \theta(\tau) \right]$$

Where the functions obey

$$\dot{a} = \frac{2\Gamma}{\pi} - \tilde{\zeta} a - \Phi \sin(\theta)$$

$$\dot{\theta} = \Delta\omega + \frac{3\omega_n}{8\omega_d} a^2 - \frac{\Phi}{a} \cos(\theta)$$

The Adler Equation

Assuming the amplitude converges rapidly, the dynamics is given by the phase function ϕ , which can be reduced to

$$\dot{\phi} \approx B[K - \sin(\phi)]$$

Where $K = \frac{\Delta\omega}{B}$, $\Delta\omega$ is the phase offset and B is a physical parameter of the beam

This Adler equation has a closed analytical solution!

Simulating Adler's equation with Matlab for values that obey

$$\lim_{K \rightarrow 1^+} \phi(t)$$

will yield the desired comb!

Phase Time Response

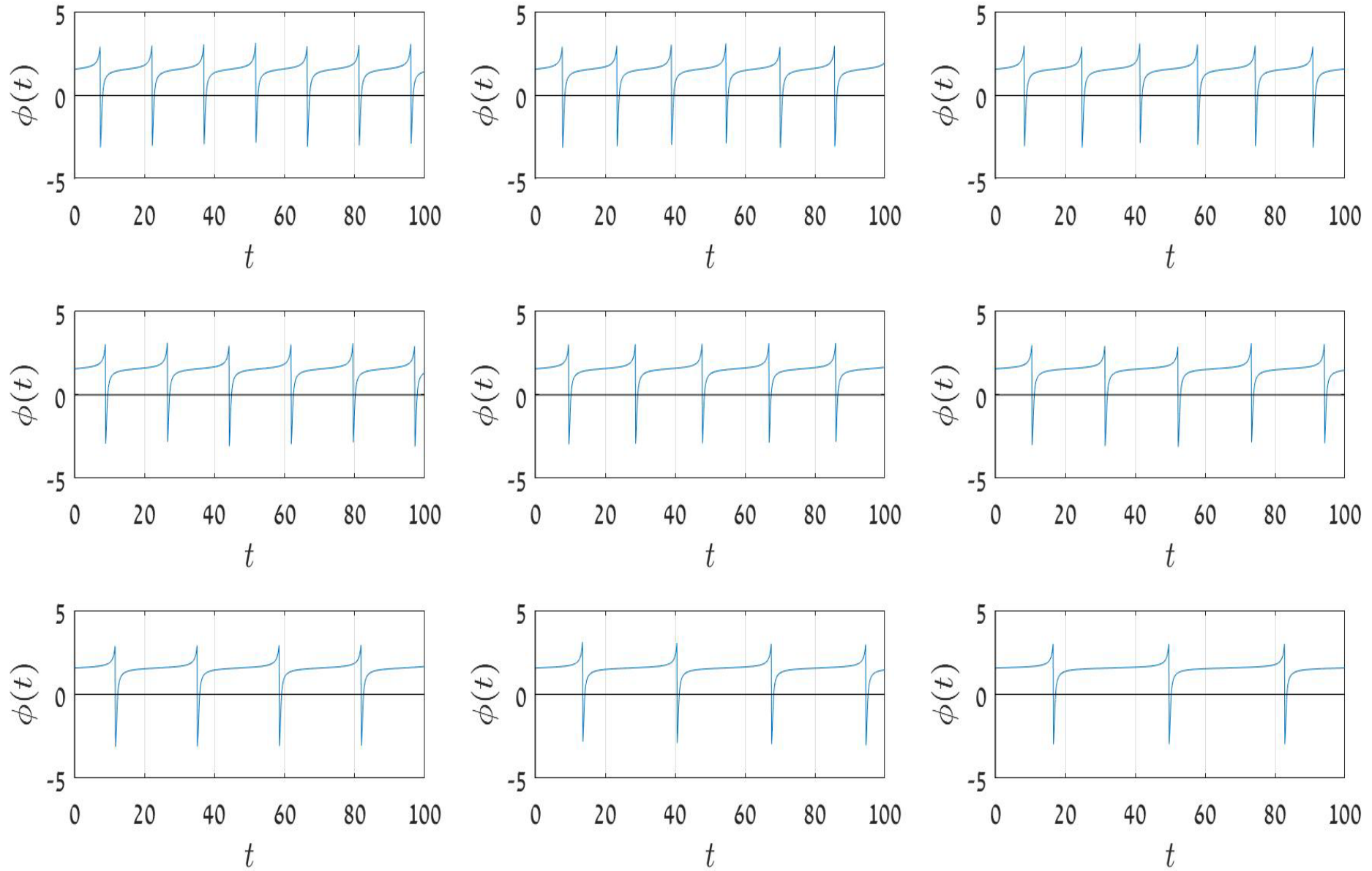

$B = 3 ; K \in [1.002, 1.01]$

Phase Frequency Response

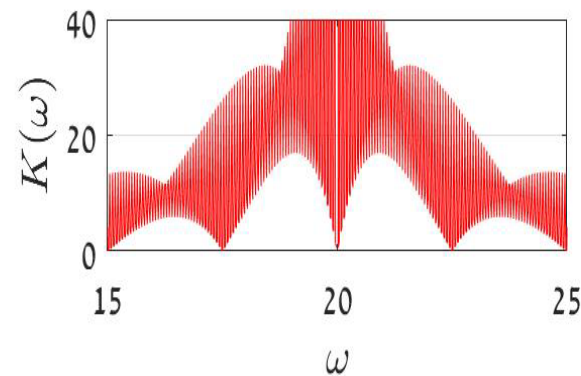
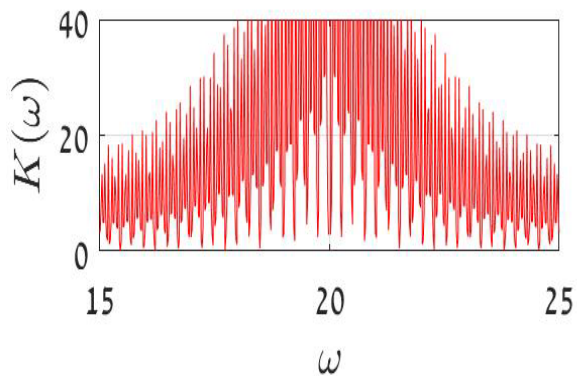
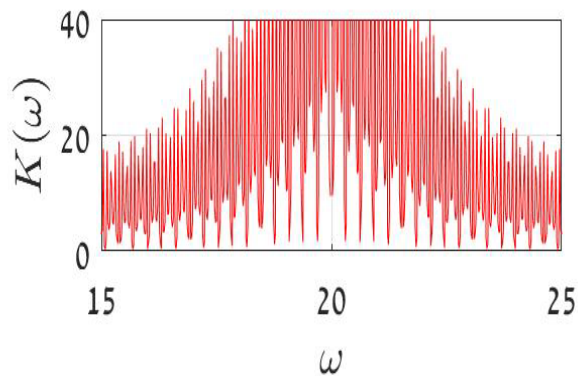
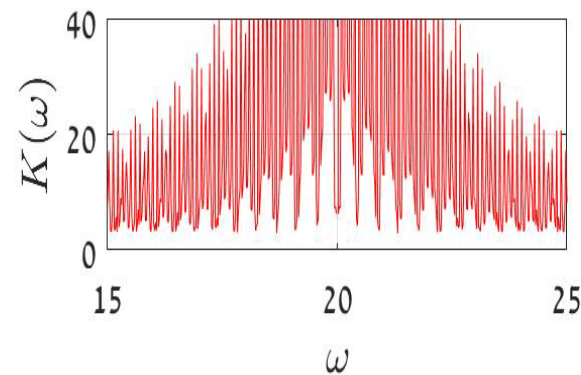
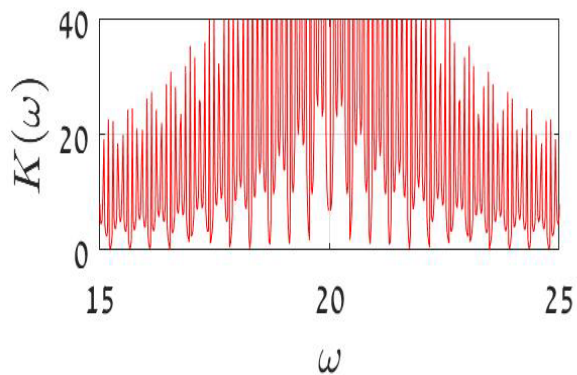
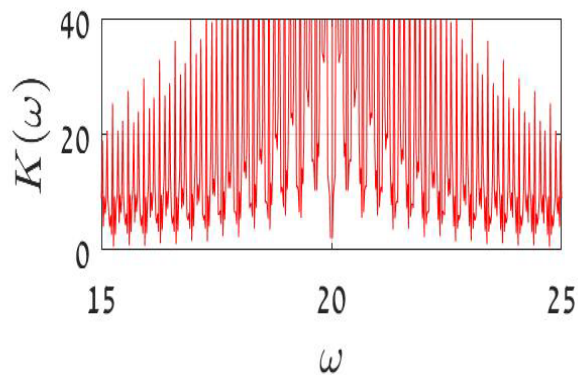
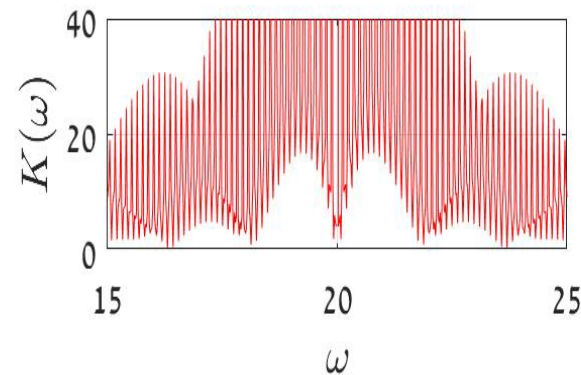
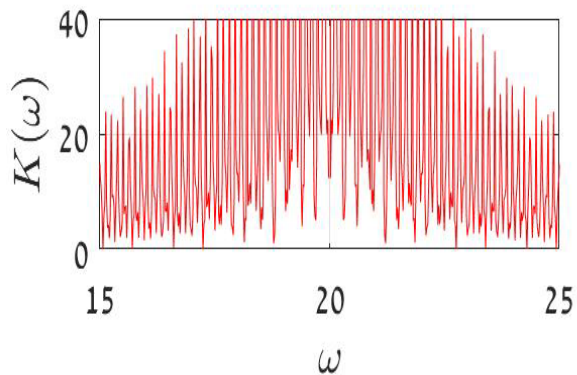
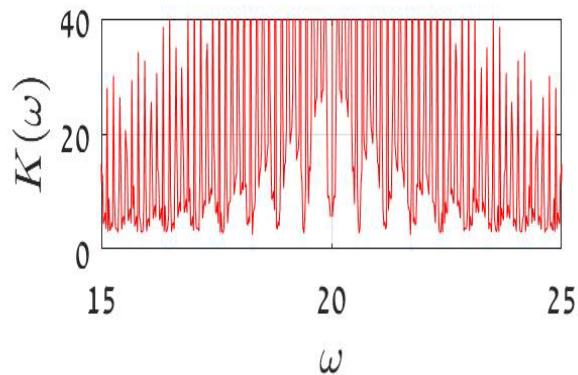

$B = 3 ; K \in [1.002, 1.01]$

Phase Time Response

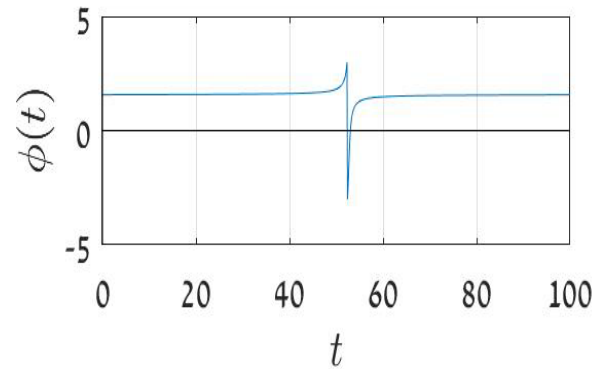
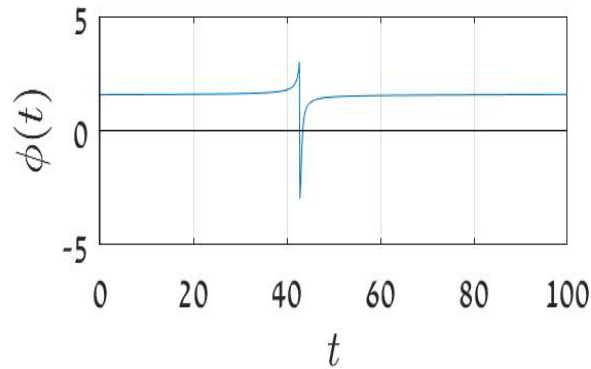
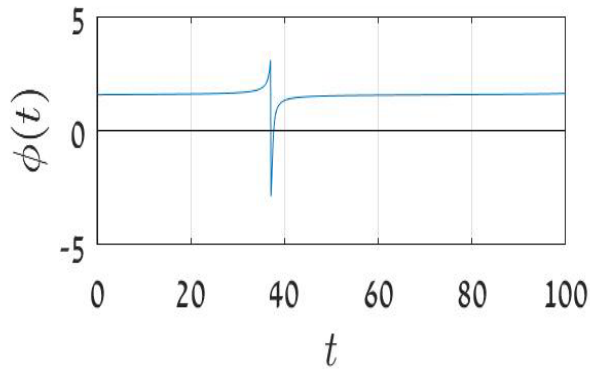
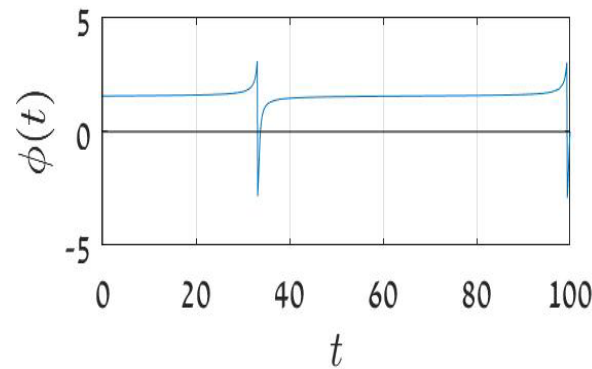
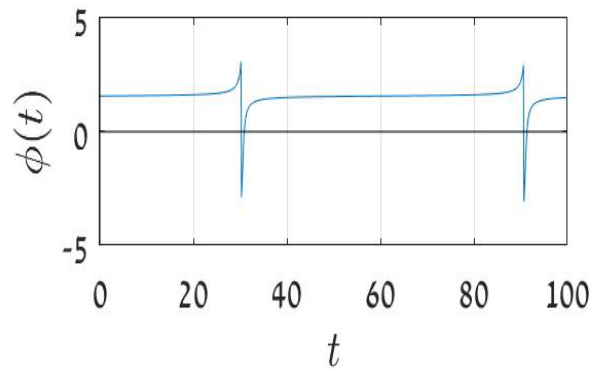
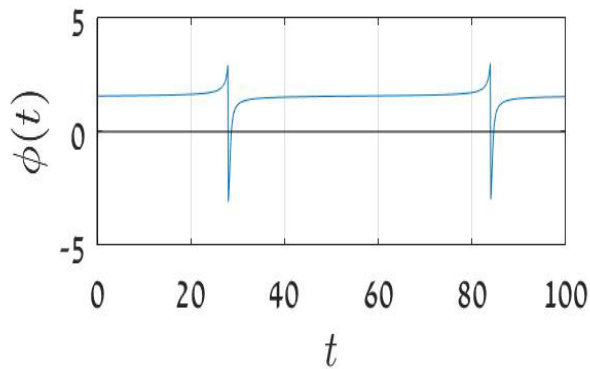
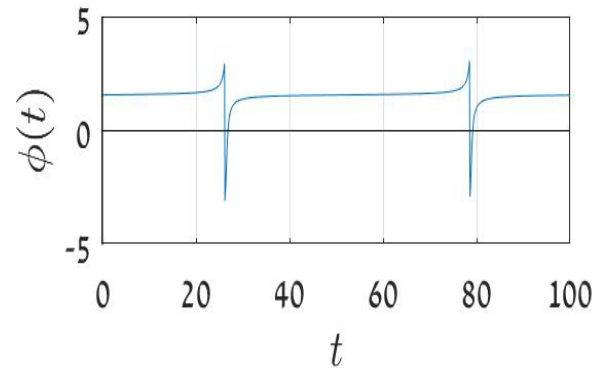
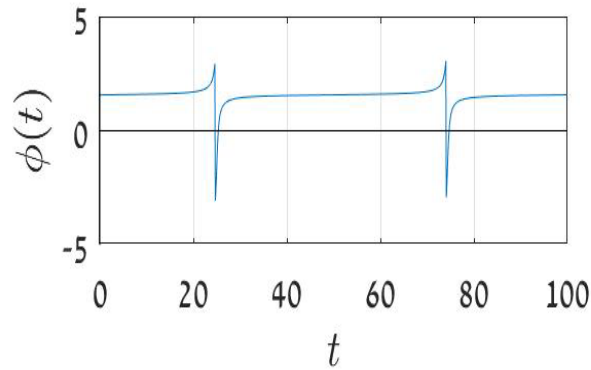
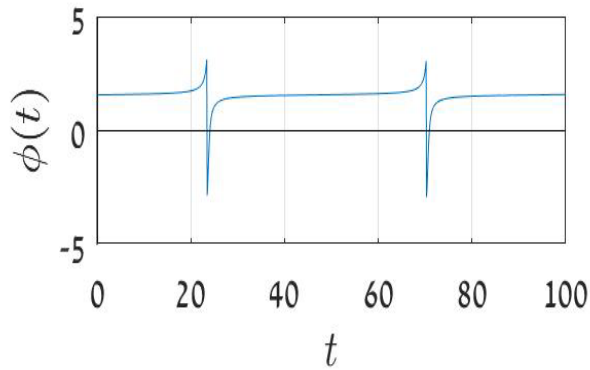

$B = 3 ; K \in [1.0002, 1.001]$

Phase Frequency Response

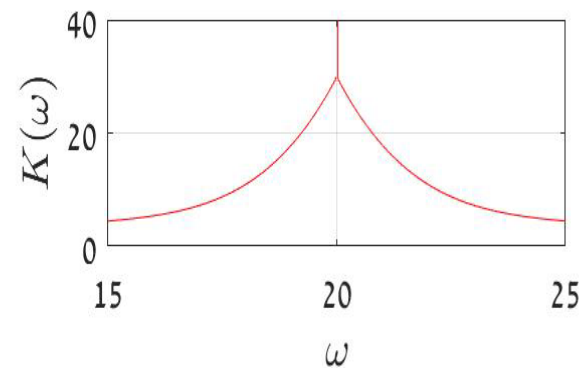
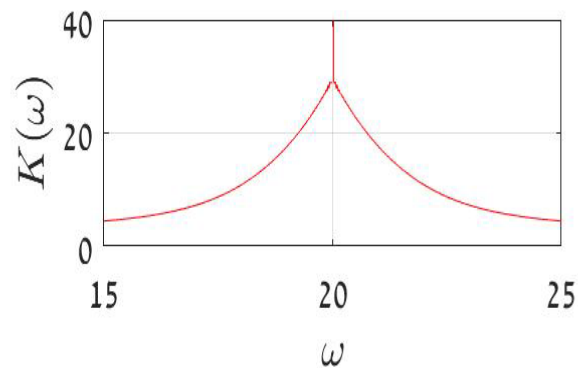
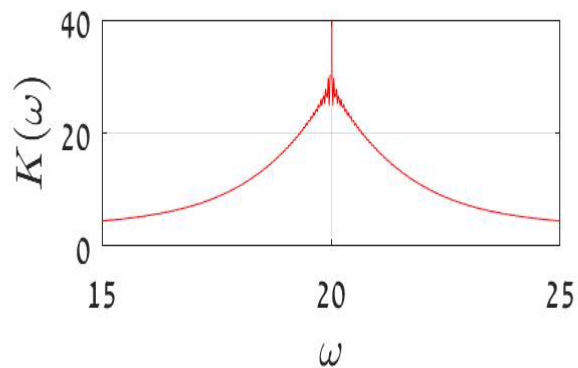
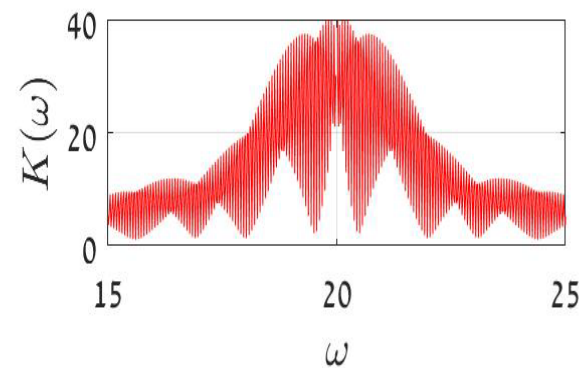
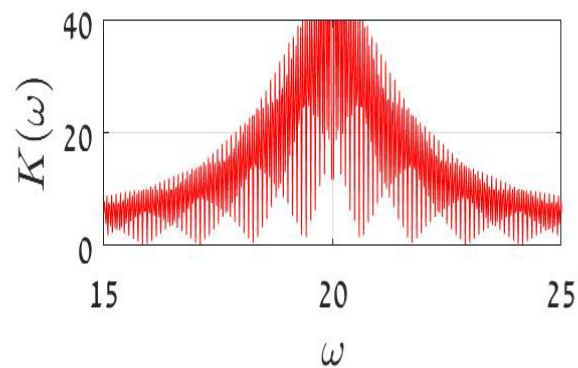
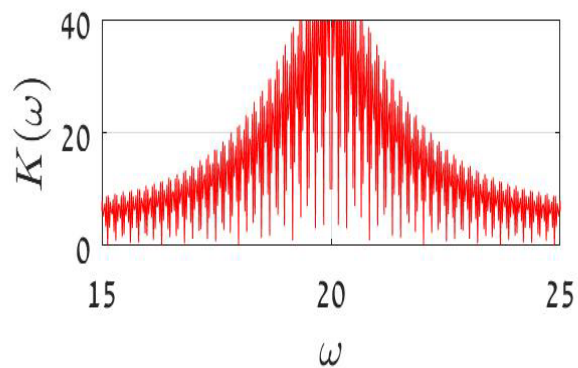
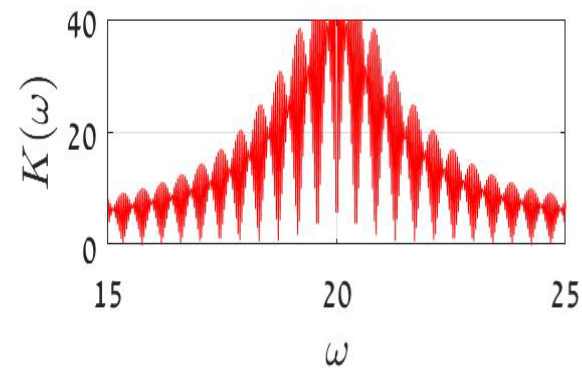
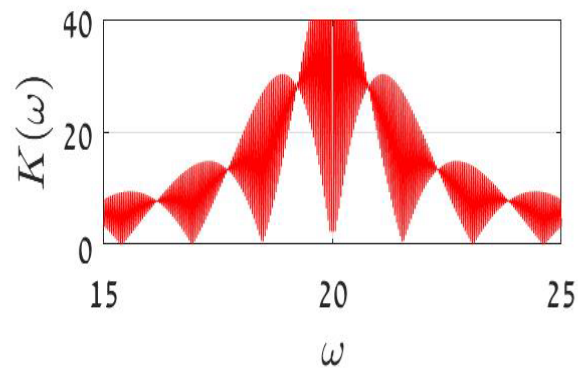
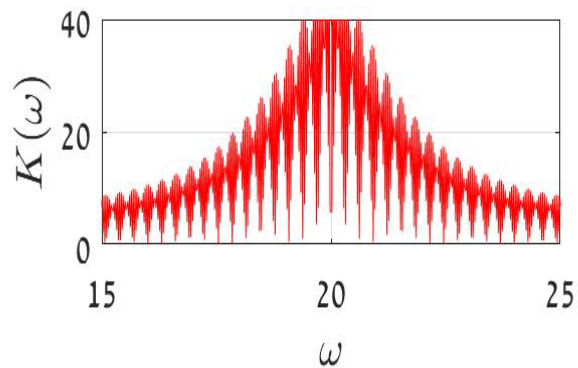

$B = 3 ; K \in [1.0002, 1.001]$

Phase Time Response

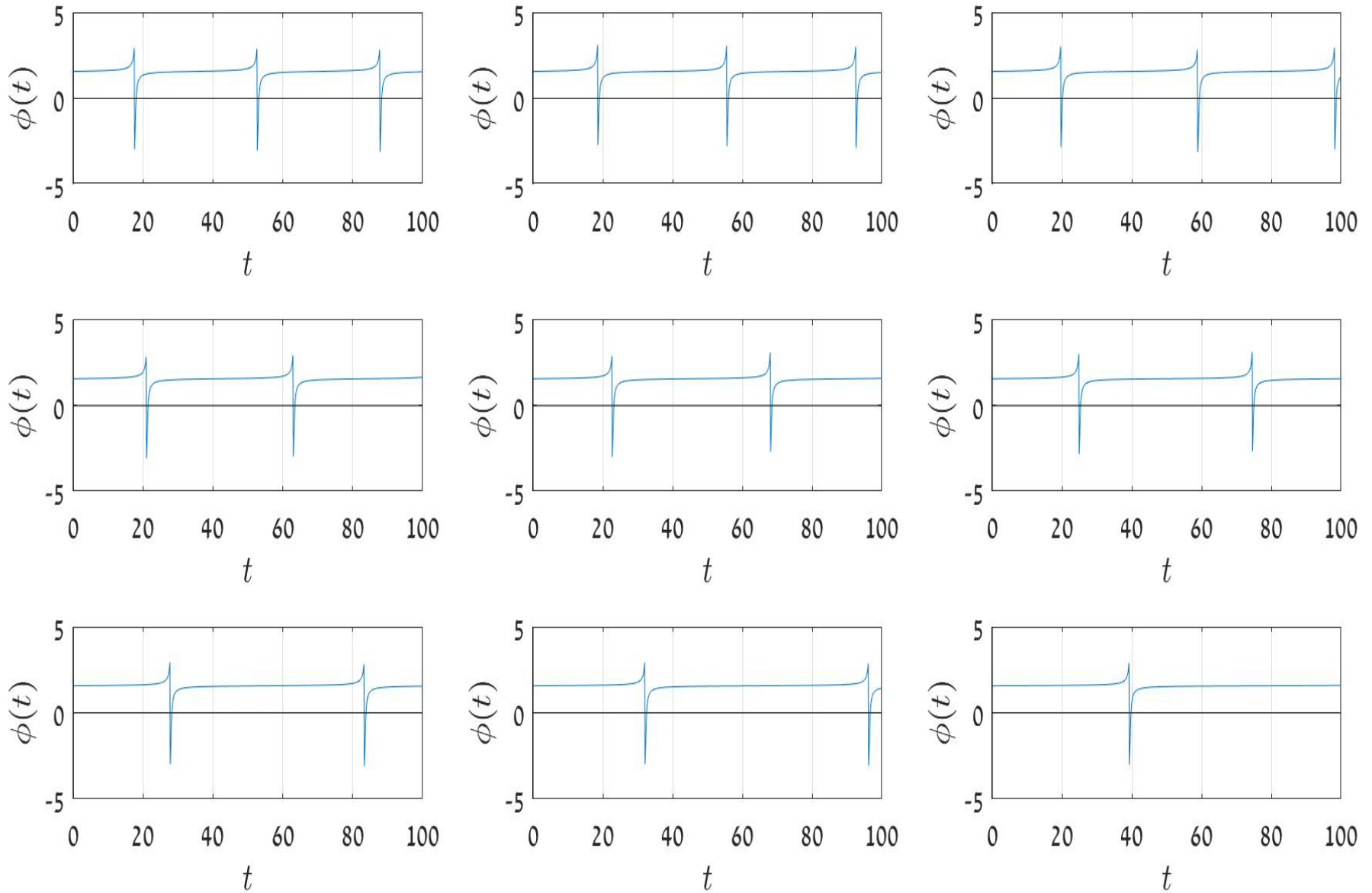

$B = 4 ; K \in [1.0002, 1.001]$

Phase Frequency Response

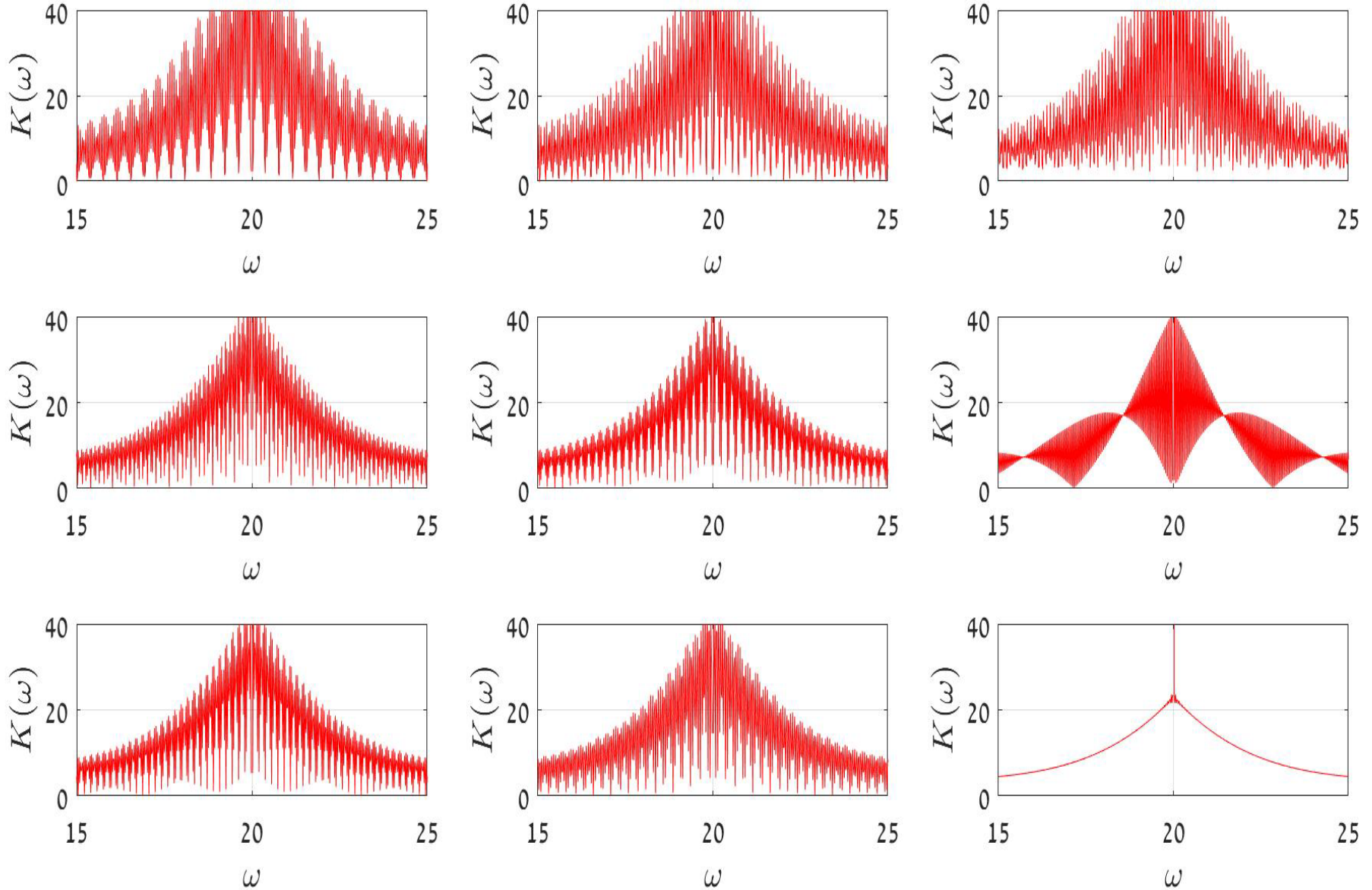

$$B = 4 ; K \in [1.0002, 1.001]$$

Observations and Conclusions

- The control function is satisfactory
- The system dynamics can be reduced to a simple model that can be applicable to MEMS with suitable parameters
- The model is suitable for comb extraction
- Values of the parameters highly effect the comb density and overall appearance



Future Work

